

HAZET®

179 NT-8

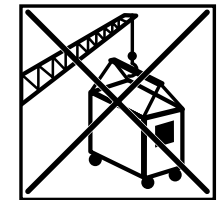

179 NT-8

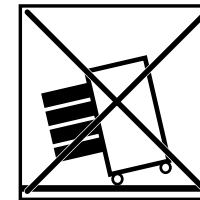
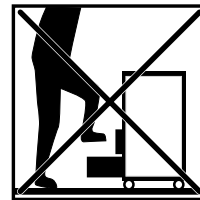
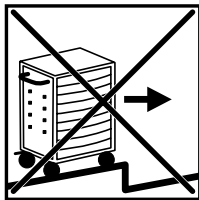
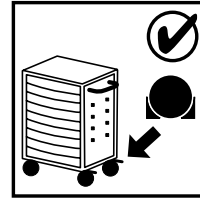
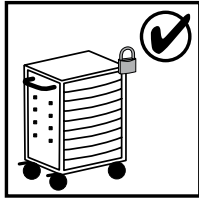
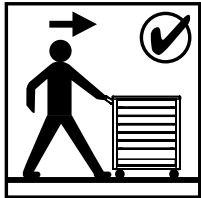
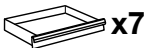

x7

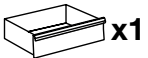

x1

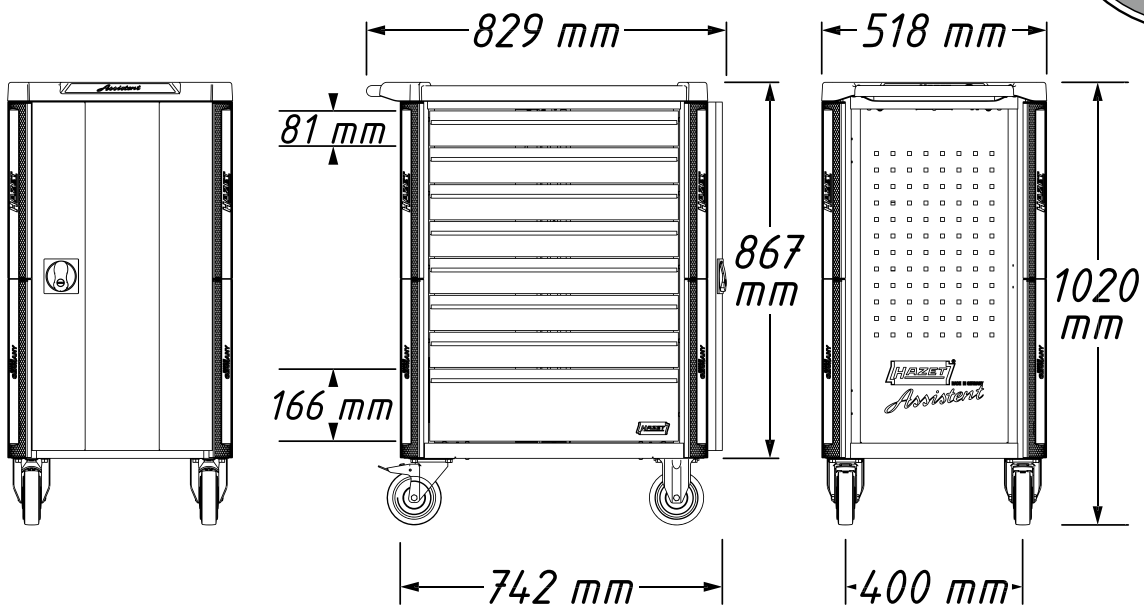
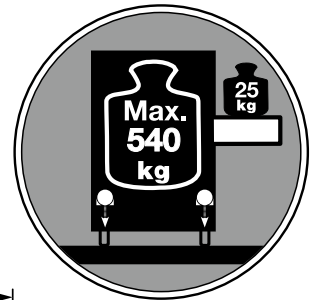

www.hazet.de/de/produkte



www.hazet.de/produkte/betriebs-und-werkstatteinrichtung

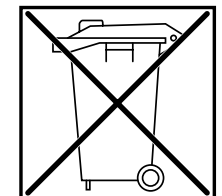
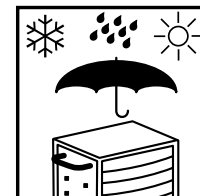
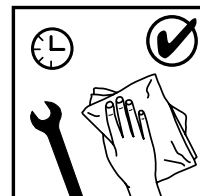

Ersatzteile 179 NT-8

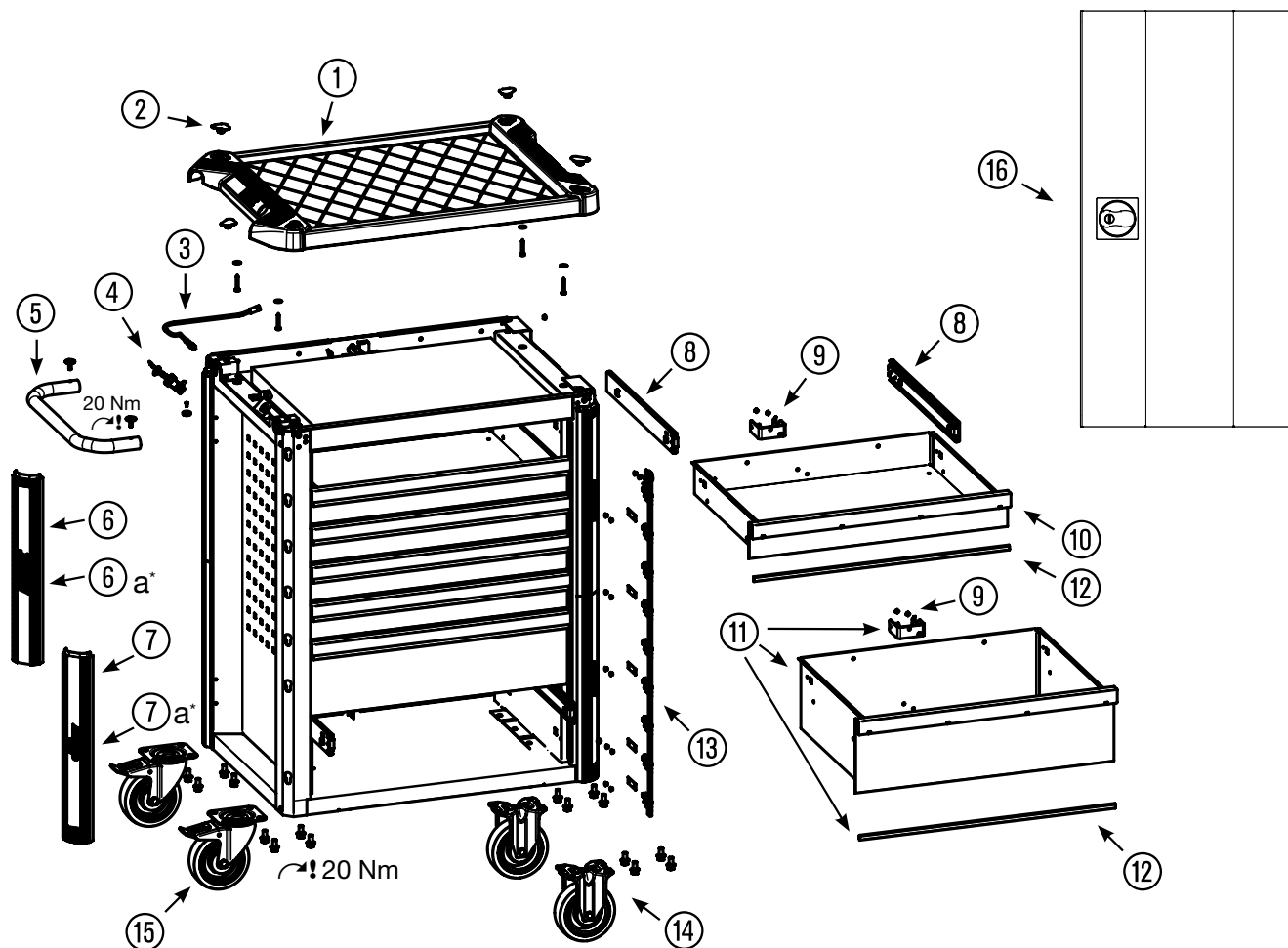

	HAZET No.		179 NT-8	
①	179 N-05	Kunststoff-Arbeitsplatte	1	1
②	179 N-05K	Abdeckkappe	1	4
③	179 N-01	Seilzug	1	1
④	179 N-08	Zylinderschloss mit 2 Schlüsseln	1	1
⑤	179 N-06	Fahrgriff	1	1
⑥	179 N-094	Kantenschutz oben (Hazet)	4	1
⑥a*	179 N-094 A	Kantenschutz oben (Hazet)	4	1
⑦	179 N-093	Kantenschutz unten (MIG)	4	1
⑦a*	179 N-093 A	Kantenschutz unten (MIG)	4	1
⑧	179 N-07/2	Führungsschiene, per paar	8	1
⑨	179N-019	Verriegelungshaken Schublade + Nieten	7	1
⑩	179 N-050	Schubfach flach 179N	7	1
⑪	179 N-051	Schubfach hoch 179N	1	1
⑫	179 N-057	Schubladengriffprofil	7	1
⑬	179 N-04	Verriegelungsleiste + Bef. Material	1	1
⑭	178 N-09	Bockrolle	2	1
⑮	178 N-011	Lenkrolle mit Feststeller	2	1
⑯	179 N-21	Tür 179N	1	1

*ab dem 01.05.2019 neuer Kantenschutz